

DVD 27 Digital Versatile Disc Player

OWNER'S MANUAL

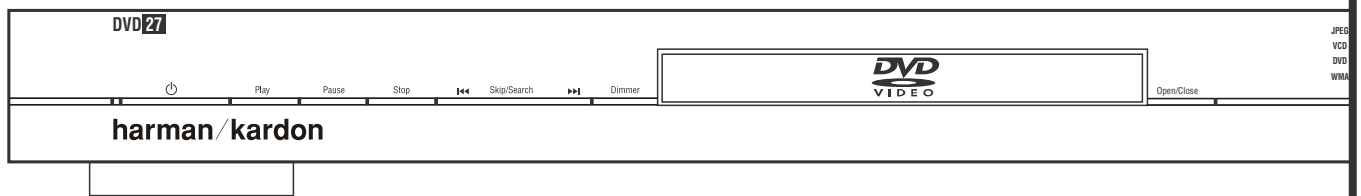

harman/kardon®
Designed to Entertain.™

Table of Contents

- 3 Introduction
- 4 Terminology
- 5 Features, Packing List
- 6 Front Panel Controls
- 7 Front Panel Information Display
- 8 Remote Control
- 10 Rear Panel Connections
- 11 Setup and Connections
 - 11 to a Stereo TV and Stereo or Pro Logic Amplifier/Receiver
 - 12 to a Dolby Digital/DTS Amplifier/Receiver
 - 13 to a TV or monitor with SCART or Component Connectors
- 14 Remote Control
- 15 Digital Audio Connections
- 16 Playback Basics
 - 16 Basic Play
 - 16 Playback Features
- 16 About DivX Movie Files
- 17 System Set-up
 - 18 System Settings
 - 18 Audio Settings
 - 19 Video Settings
- 20 Test Screen
 - 20 Test Screen
 - 20 TV Picture Adjustment
- 21 Player Menu
 - 21 Using the Player Information Menu
- 22 CD Playback
- 24 MP3, Windows Media and JPEG Playback
- 26 Troubleshooting Guide
- 27 DVD Language Codes
- 27 Specifications

Declaration of Conformity



We, Harman Consumer Group International
2, Route de Tours
72500 Château-du-Loir,
FRANCE

declare in own responsibility, that the product described in this owner's manual is in compliance with technical standards:

EN 55013:2001

EN 55020:2002

EN 61000-3-2:2000

EN 61000-3-3:1995+A1:2001

EN 60065:2002

Jurjen Amsterdam
Harman Consumer Group International
01/06

NOTE: This player is designed and manufactured for compatibility with Region Management Information that is encoded on most DVD discs. This player is designed only for

playback of discs with Region Code 2, or for discs that do not contain Region Code information. If there is any other Region Code on a disc, that disc will not play on the DVD.



CAUTION

**RISK OF ELECTRIC SHOCK
DO NOT OPEN**



CAUTION: TO REDUCE THE RISK OF ELECTRIC SHOCK, DO NOT REMOVE COVER (OR BACK). NO USER-SERVICEABLE PARTS INSIDE. REFER SERVICING TO QUALIFIED SERVICE PERSONNEL.



The lightning flash with arrowhead symbol, within an equilateral triangle, is intended to alert the user to the presence of uninsulated "dangerous voltage" within the product's enclosure that may be of sufficient magnitude to constitute a risk of electric shock to persons.



The exclamation point within an equilateral triangle is intended to alert the user to the presence of important operating and maintenance (servicing) instructions in the literature accompanying the appliance.

WARNING: TO REDUCE THE RISK OF FIRE OR ELECTRIC SHOCK, DO NOT EXPOSE THIS APPLIANCE TO RAIN OR MOISTURE.

Introduction

Thank you for choosing the Harman Kardon DVD

The DVD is a multipurpose DVD player, capable of playing both DVD-Video discs and conventional CD audio discs with the highest fidelity and access to future software upgrades via the Internet. Along with conventional Video and CD audio discs, the DVD 27 is also compatible with MP3, CD-R and CD-RW as well as DivX® and VCD discs.

To enable you to get the maximum quality from DVDs, the DVD is equipped with the latest in design techniques, including advanced 10-bit video digital-to-analog converters (DAC) and Video (composite), S-Video and RGB video (RGB via SCART) outputs, to ensure that you get all the quality inherent in today's DVD medium. For optimum playback of NTSC and PAL DVD with compatible high-definition display devices, DVD is equipped with progressive component video outputs.

In addition, Harman Kardon's audio heritage continues into the digital video era with audiophile-grade DACs to ensure that the audio quality matches the superb video. Of course, both coaxial and optical digital audio outputs are available for direct connection to A/V receivers or processors so that you may take advantage of Dolby Digital* and DTS® soundtracks. When playing audio CDs, the playback quality is state-of-the-art, matching that of the finest players available.

A wide range of programming features makes it easy to program an evening's worth of entertainment. When playing DVDs, easy-to-understand on-screen menus and icons make it simple to change languages, soundtracks, subtitles or aspect ratio.

DVD players are among the fastest growing consumer electronics products ever brought to market, but this may, nevertheless, be the first DVD player you've owned. Although many of the features of the DVD resemble those of standard CD players, there are a number of functions that you may be unfamiliar with. To ensure that you are able to take advantage of all the power and flexibility the DVD has to offer, we encourage you to review this quick setup manual. That small investment of your time will pay major dividends in the enjoyment you will get from proper use of the DVD.

If you have additional questions about this product or its installation or operation that are not answered in this manual, please contact your dealer, as he is your best source of local information.

- **Plays a Wide Range of Video and Audio Formats, Including DVD-Video Discs, VCD, Standard CD Audio Discs, CD-R/RW, DVD-R/RW, DVD+R/RW, Audio Discs and MP3 Discs**
- **High-Quality Video Playback 10-Bit DACs, Progressive Scan and Component Video Outputs**
- **Dolby Digital and DTS Data Signal Output Through Both Optical and Coaxial Digital Audio Connections**
- **Audiophile-Grade Output DACs for the Finest Audio reproduction**
- **Easy-to-Use On-Screen Navigation System**
- **Playback of MP3 and Windows® WMA Audio Discs and JPEG image files**
- **Parental Lock Controls Prevent Unauthorized Viewing of Restricted Movies**
- **Playback of DivX compressed video files**
- **Extensive Programming Capability for Audio and Video Discs**
- **Multiple Options for Language, Soundtrack and Subtitle Selection**
- **Multiple-Angle Capabilities With Specially Encoded DVD Discs**
- **Backlit, Ergonomically Designed Remote Control**

Terminology

Terminology

Since they share some of the characteristics and technology of CD players, many of the terms and operational concepts used in a DVD player are similar to what you may be familiar with from CD players and changers, or older video disc formats such as Laser Disc. However, if this is your first DVD product, some of the terms used to describe the features of a DVD player may be unfamiliar. The following explanations should solve some of the mysteries of DVD, and help you to enjoy all the power and flexibility of the DVD format and the DVD.

With the arrival of DVD, disc data capacity has increased dramatically. On a DVD Video disc most of this capacity is taken up by MPEG 2 video and the multichannel movie soundtrack in Dolby Digital and/or DTS. This information is compressed.

Aspect Ratio: This is a description of the width of a video image in relation to its height. A conventional video screen is four units wide for every three units of height, that's why the ratio is called "4:3". Newer wide aspect ratio video displays are 16 units wide for every nine units of height, making them more like the screen in a movie theater. The program material on a DVD may be recorded in either format and, in addition, you may configure the DVD to play back in either format, depending on the features recorded on a disc.

Title: For a DVD, a title is defined as an entire movie or program. There can be as many chapters within a title as the producers decide to include. Most discs include only one title, but some may have more than one, to give you a "Double Feature" presentation.

Chapter: DVD programs are divided into chapters and titles. Chapters are the sub-sections programmed into a single title on a disc. Chapters may be compared to the individual tracks on an audio CD.

RGB Video: This is a new form of video signal that eliminates many of the artifacts of traditional composite video signals by splitting the signal into the three fundamental colors Red, Green and Blue (RGB). With an RGB connection (via SCART), you will see greater picture resolution and eliminate many picture imperfections such as the moiré patterns often seen on checkered patterned cloths. However, in order to benefit from RGB video, you must have a video display with an RGB compatible SCART input.

Progressive scan: DVD offers progressive scan video outputs for use with compatible high-resolution televisions and projectors. Before DVD, no consumer medium could store, transmit or display video with full resolution. To conserve bandwidth, analog compression (interlacing) is employed: first the odd-numbered lines of a frame are displayed, followed by the even-numbered lines. The result is that only half of the video image is drawn at one time; the viewer's brain must reassemble the complete image. This is acceptable, if the monitor is not too large and if there is not too much motion in the image. Large displays and fast-moving images reveal the limitations of this system. Thanks to DVD's immense data capacity, images are now stored intact (progressively), so that all the lines in each frame (odd and even) are shown at the same time. But because most TV's cannot handle a progressive signal, all current DVD players generate an interlaced output for compatibility. Now, the Harman Kardon DVD is among the select few DVD players with true progressive scan video output (NTSC and PAL) for use with compatible TV's and CRT projectors and with all plasma, LCD and DLP display devices via the component video output. The result is 40% greater light output than a conventional TV and a stunningly detailed high definition image, along with an almost complete absence of visible scanlines and motion artifacts. Of course, traditional Y/Pr/Pb component video, SCART, S-Video and composite video outputs are included for use with conventional televisions and projectors.

Multiple Angle: DVDs have the capability to show up to four different views of the same scene in a program. When a disc is encoded with multiple-angle information, pressing the Angle button will enable you to switch between these different views. Note that at present, few discs take advantage of this capability and, when they do, the multiple-angle technology may only be present for short periods of time within the disc. Producers will usually insert some sort of icon or graphic in the picture to alert you to the availability of multiple viewing angles.

Reading: This is a message that you will see after you've loaded the disc and the tray has closed. It refers to the fact that the player must first examine the contents of the disc to see if it is a CD or DVD, and then extract the information about the type of material on the disc, such as languages, aspect ratios, subtitles, number of titles and more. The slight delay while the contents of the disc are read is normal.

Resume: The operation of the Stop Button on the DVD works differently from what you are used to on CD players. On a traditional CD player, when you press the Stop button, the unit does just that: it stops playback. On a CD player, when you press the start button again, the disc starts from the beginning. With the DVD, however, you have two options when playing DVD discs. Pressing Stop once will stop playback, but it actually puts the unit in the Resume mode. This means that you can turn the machine off and, when you press play the next time, the disc will resume or continue from the point on the disc where the Stop button was pressed. This is helpful if you are watching a movie and must interrupt your viewing session but wish to pick up where you left off. Pressing the Stop button twice will stop the machine in a traditional manner and, when the disc is played again, it will start from the beginning.

In resume mode, the cover of the DVD will be displayed, if available. Otherwise, the Harman Kardon screen will appear.

DivX

DivX is the name of a revolutionary new video codec which is based on the MPEG-4 compression standard for video. This DVD player will play-back discs created with DivX software. The DVD player's playback functionalities of DivX video discs will vary depending on the DivX software version used for creating your movies. For more information about the different software versions of DivX, please go to www.divx.com.

Features

High quality video

- Advanced sophisticated 10-bit MPEG-2 video decoding circuits.
- Direct RGB output via SCART (selectable) for optimum video performance. SCART connector also configurable for Composite Video output.
- Test screen videos available for testing video performance and setup.
- Pure PAL with NTSC disc due to true NTSC/PAL conversion.
- Dual-layer compatibility for extended play DVD.
- Progressive Scan component video outputs (NTSC and PAL)
- Playback of JPEG image files

High quality digital audio

- By connecting a DTS (Digital Theater Systems) or a Dolby Digital decoder, you can enjoy high quality 5.1 digital surround sound from DTS or Dolby Digital discs.
- With linear PCM audio at 16-24 bits and 44-96 kHz (also on digital output, see table page 15), audio quality exceeding that of CD becomes possible.
- Optical and coaxial digital audio output.

Many convenient features

- On-Screen Menu Icons for disc information or player information and access to many major functions of this unit.
- Subtitles may be displayed in one of numerous languages*.
- The multi-angle function allows you to choose the viewing angle of scenes which were shot from a number of different angles (Limited to DVD's recorded with multiple camera angles.)
- Multiple options for dialog language and soundtrack selection (limited to DVD's recorded with multiple dialog languages or soundtracks).
- Intuitive menu operating system.
- 4 step Zoom during play and pause.
- Backlit, ergonomically designed remote control.
- Future software upgrades accessible via Internet. (See information below.)

* The number of languages recorded depends on the software.

Compatible with CD as well as DVD

- The DVD 27 will play any conventional Audio CD or recordable (CD-R) or erasable CD (CD-RW), MP3, WMA (v8) or any DivX or VCD or DVD/Video with the region code 0 or 2.

Disc formats supported by this player

The unit can play the following disc formats (8 cm and 12 cm size):

- DVD
- DVD-R
- DVD-RW
- DVD+R
- DVD+RW
- CD
- CD-R
- CD-RW
- VCD
- S-VCD
- WMA (v8)

NOTE: Due to differences in the format of certain discs, it is possible that some discs may include a mix of features that are not compatible with the DVD. Similarly, although the DVD is capable of a wide range of features, not all discs include every capability of the DVD system. For example, although the DVD is compatible with multi-angle discs, that feature is only possible when the disc is specially encoded for multiple-angle play. In addition, the DVD is capable of playing back both Dolby Digital and DTS soundtracks, but the number and types of tracks available will vary from disc to disc. To make certain that a specific feature or soundtrack option is available, please check the options noted on the disc jacket.

■ Playback capability for CD-R, CD-RW, WMA, JPEG, MP3, DivX, VCD/SVCD, DVD-R, DVD+R, DVD-RW and DVD+RW discs may vary due to variations in the quality of the disc and the recorder used to create the disc.

■ The DVD 27 is compatible with most discs recorded with files encoded using MP3 or Windows Media 8, as well as JPEG still images. However, note that variations in the encoder or codec used and the bit rate of the encoding may affect the DVD 27's ability to play back a specific disc. As a result, we cannot guarantee complete compatibility with all encoders and versions of the codecs. For best results, we recommend that MP3 files be encoded at bit rates ranging between 32kbps and 320kbps. WMA files should be encoded at bit rates between 64kbps and 320kbps. Although the DVD 27 is capable of playing some WMA 9 files, not all features of version 9 are supported. JPEG files should contain no more than 5 megapixels, and the file size should be no larger than 5Mb.

Upgradeability via Internet

The "firmware" controlling the functionality of the Harman Kardon DVD is fully upgradeable. In the event of future improvements to its operations and features, it will be possible to download firmware upgrades from www.harmankardon.com/International/ All you have to do is create a CD-R with the data and insert it in the DVD for an automatic upgrade.

Packing List

- 1 Harman Kardon DVD Player
- 1 Remote control
- 2 AA batteries
- 1 A/V cable for stereo analog audio and composite video
- 1 S-Video cable
- 1 remote extension cable
- 1 owner's manual

Front Panel Controls



- | | | |
|-----------------------------------|----------------|---------------------------------|
| 1 Main Information Display | 4 Play | 7 Skip/Search (Previous) |
| 2 Power On/Off (Standby) | 5 Pause | 8 Skip/Search (Next) |
| 3 Open/Close | 6 Stop | 9 Display |

1 Main Information Display: This display delivers messages and status indications to help you operate the DVD player.

2 Power On/Off (Standby): Press the button once to turn the DVD player on, press it again to put the unit in the Standby mode.

3 Open/Close: Press this button to open or close the Disc Tray.

4 Play: Press to initiate playback or to resume playback after Pause has been pressed.

5 Pause: Press this button to momentarily pause playback. To resume playback, press the button again. If a DVD is playing, action will freeze and a still picture will be displayed when the button is pressed.

6 Stop: Press this button once to place the disc in the Resume mode, which means that playback will stop, but as long as the tray is not opened or the disc changed, DVD playback will continue from the same point on the disc when the Play Button is pressed again. Resume will also work if the unit was turned off. To stop a disc and have play start from the beginning, press the button twice.

7 Skip/Search (Previous): Press this button to move backward through the music tracks on a CD disc or the chapters on a DVD disc. Keep the button pressed to search backwards at one of the available speeds.

8 Skip/Search (Next): Press to move forward through the music tracks on a CD or the chapters on a DVD disc. Keep the button pressed to search forwards at one of the available speeds.

9 Display: Press this button to reduce the brightness of the Information Display by 50% or to turn the display off completely in the following order: FULL BRIGHTNESS → HALF BRIGHTNESS → OFF → FULL BRIGHTNESS.

Front Panel Information Display

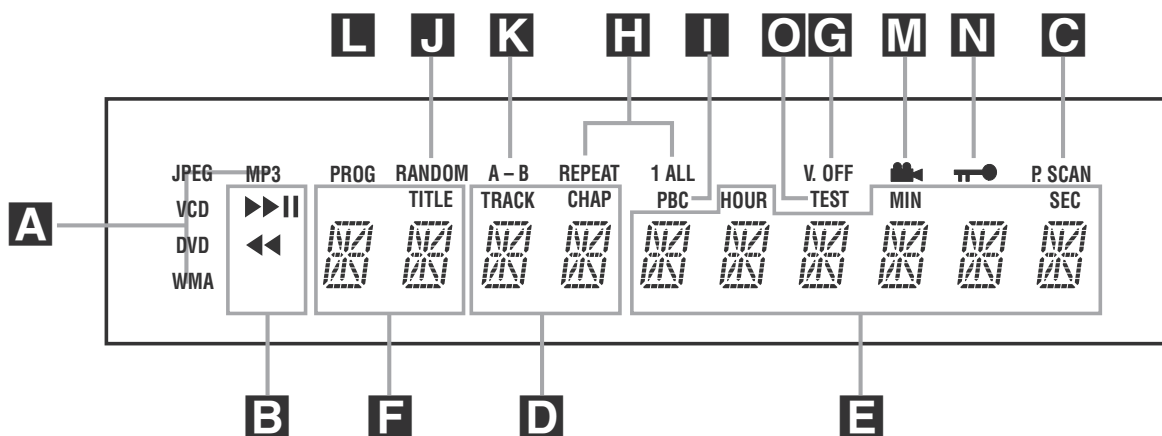

- A** Disc Type Indicators
- B** Playback-Mode Indicators
- C** Progressive Scan Indicator
- D** Chapter/Track Number Indicators
- E** Time Indicators

- F** Title Indicators
- G** V-Off Indicator
- H** Repeat Indicators
- I** VCD Playback Control Indicator
- J** Random Indicator

- K** A-B Repeat Indicator
- L** Program Indicator
- M** Angle Indicator
- N** Parental Lock Indicator
- O** Test Indicator

A Disc Type Indicators: The CD, DVD or DVD Audio indicator will illuminate to show the type of disc currently being played.

B Playback-Mode Indicators: These indicators light to show the current playback mode:

▶ Lights when a disc is playing in the normal mode

▶▶ Lights when the disc is in the Fast Search Forward mode. The on-screen banner display indicates the selected speed (x2, x4, x8, x20, x100).

|| Lights when the disc is paused.

◀◀ Lights when the disc is in the Fast Search Reverse mode. The on-screen banner display indicates the selected speed (x2, x4, x8, x20, x100).

C Progressive Scan Indicator: This indicator lights when the unit sends out a progressive scan signal.

D Chapter/Track Number Indicators: When a DVD disc is playing, these two positions in the display will show the current chapter. When a CD disc is playing they will show the current track number.

E Time Indicators: These positions in the indicator will show the running time of a DVD in play. When a CD is playing, these indicators will show the current track time, time remaining in the current track, or the total remaining time on the disc.

NOTE: The Indicators **DEF** will also display text messages about the DVD's status, including **L O A D I N G** when a disc is loading, **P O W E R O F F** when the unit is turned off, and **D I S C E R R O R** when a disc not compatible with the DVD is put into the play position.

F Title Indicators: These two positions in the display will show the current title number when a DVD disc is playing.

G V-Off Indicator: This indicator lights when the unit's video output has been turned off by pressing the V-OFF button on the remote control.

H Repeat Indicators: These indicators light when any of the Repeat functions are in use.

I VCD Playback Control Indicator: This indicator lights when the playback control function is turned on with VCDs.

J Random Indicator: This indicator lights when the unit is in the Random Play mode.

K A-B Repeat Indicator: This indicator lights when a specific passage for repeat playback has been selected.

L Program Indicator: This indicator lights when the programming functions are in use.

M Angle Indicator: This indicator blinks when alternative viewing angles are available on the DVD currently playing.

N Parental Lock Indicator: This indicator lights when the parental-lock system is engaged in order to prevent anyone from changing the rating level without a code.

O Test Indicator: This indicator lights when the TV test screen is activated.

Remote Control Functions

- 1 POWER ON
- 2 POWER OFF
- 3 SUBTITLE
- 4 TITLE
- 5 ANGLE
- 6 AUDIO
- 7 ENTER
- 8 OPEN/CLOSE
- 9 SETUP
- 10 ARROWS
- 11 INFO
- 12 MENU
- 13 PAUSE
- 14 STATUS
- 15 SKIP/STEP (PREVIOUS)
- 16 SKIP/STEP (NEXT)
- 17 PLAY
- 18 SEARCH/SLOW REVERSE
- 19 STOP
- 20 SEARCH/SLOW FORWARD
- 21 DIMMER
- 22 PROGRESSIVE SCAN/INTERLACED
- 23 ZOOM
- 24 PLAYLIST
- 25 RANDOM
- 26 A-B Repeat
- 27 V.OFF
- 28 LIGHT
- 29 NUMERIC KEYS
- 30 REPEAT
- 31 CLEAR
- 32 IR EMITTER

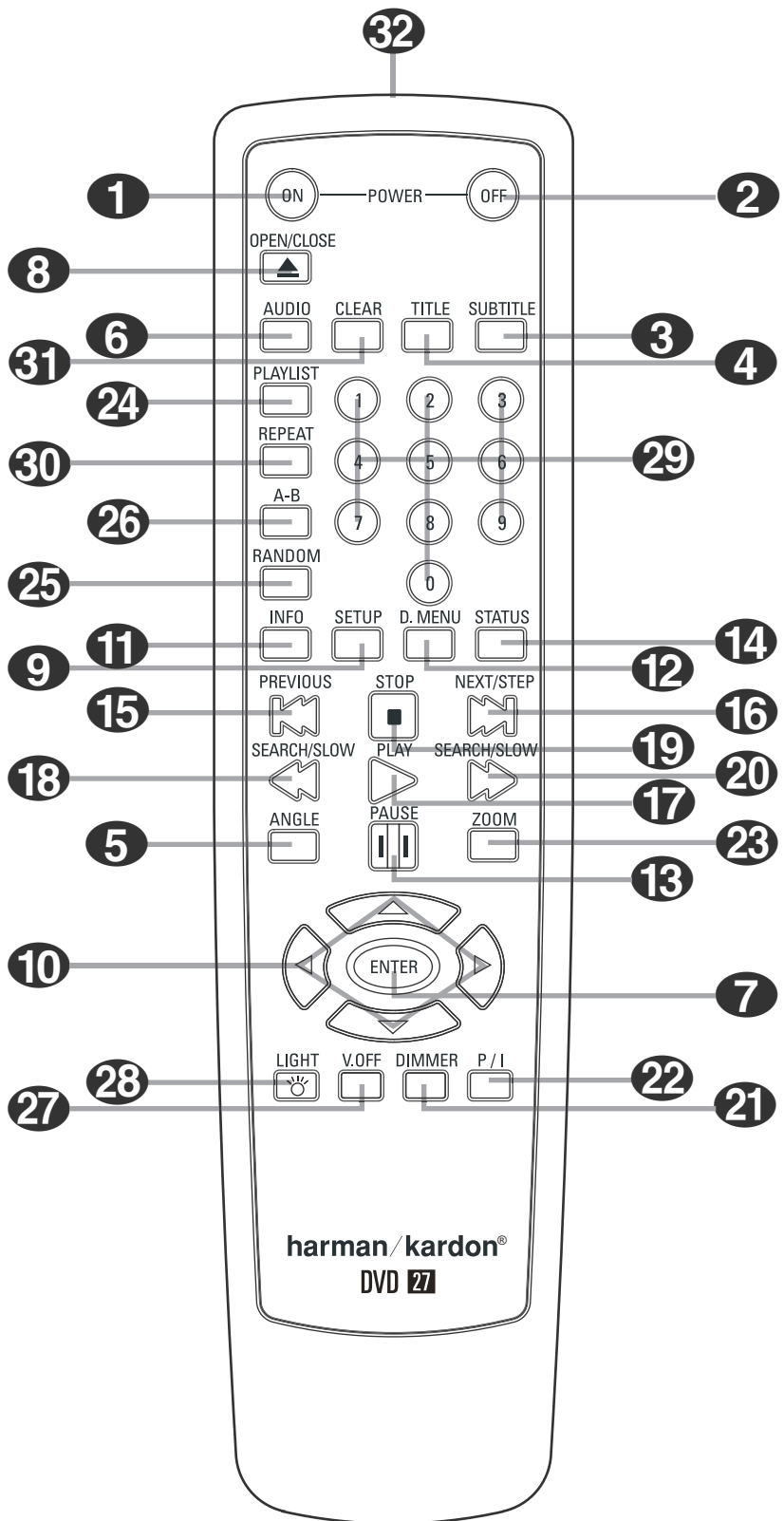

Remote Control Functions

1 POWER ON: Turns on the player when it is in standby mode (Harman Kardon logo appears on screen).

2 POWER OFF: Turns off the player to standby mode.

3 SUBTITLE: When a DVD is playing, press to select a subtitle language or to turn subtitles off.

Note: Due to the variations in how DVD discs are authored, the subtitle languages displayed by the DVD 27 may not accurately reflect the actual languages available on the disc. It is recommended that subtitles be selected using the disc's menu.

4 TITLE: When a disc is playing, press to make the player go back to the first section of the disc.

5 ANGLE: Press to access various camera angles on a DVD (If the DVD contains multiple camera angles) or to rotate JPEG images.

6 AUDIO: Press to access various audio languages on a DVD (If the DVD contains multiple audio streams).

7 ENTER: Press this button to activate a setting or option

8 OPEN/CLOSE: Press to open or close the disc tray.

9 Setup: Press this button to use the DVD 27's on-screen menu system to adjust the player's configuration settings. Note that the **Info Button** **11** must be pressed to access the DVD 27's Player Information menu to obtain detailed disc information, and to configure the playback mode of the disc.

10 ARROW buttons (◀/▶/▲/▼): Use to move the cursor in the OSD.

11 INFO: Press for detailed informations on the disc playing (Video/Audio Bit rate, Movie aspect ratio and others), and for current player settings made. Note that the unit doesn't react on any transport button as long as the info menu is displayed. Press again to remove information from screen.

12 MENU: Displays the actual DVD Disc Menu on the TV screen in play mode. When playing discs with JPEG images, pressing this button will access the thumbnails.

13 PAUSE: Freezes a picture (with DVD/VCD) and pauses the playback signal (CD) when a disc is playing. Press again for normal playback.

14 STATUS: Press while a disc is playing to view banner display. Use the ARROW buttons to move through the different features in the Banner Display. When a symbol is highlighted, press ENTER on the remote to select it.

15 SKIP/STEP (Previous): Press to go to beginning of current track. Press again quickly to go to beginning of previous track. After pressing the PAUSE button, each press of this button will move the image in reverse frame by frame.

16 SKIP/STEP (Next): Press to go to beginning of next track. After pressing the PAUSE button, each press of this button will move the image forwards frame by frame.

17 PLAY: Begins to play disc (closes disc tray first, if it is open.)

18 SEARCH/SLOW (REV): Allows you to search in reverse through a disc while it is in play mode. Each time you press this button, the search speed changes as indicated by a number of arrows on the right top of your screen. After pressing the PAUSE button, each press of this button will change the slow down speed indicated by a number of arrows in the right top of the screen.

19 STOP: Stops playing a disc. When a disc is playing, if you press STOP and PLAY, the disc will resume play, i.e. it will start from the same point on the disc where the unit was stopped. If you press STOP twice and the PLAY button, the disc will start play from the beginning.

20 SEARCH/SLOW (FWD): Allows you to search forward through a disc while it is in play mode. Each time you press this button, the search speed changes as indicated by a number of arrows on the right top of your screen. After pressing the PAUSE button, each press of this button will change the slow down speed as indicated by a number of arrows in the right top of the screen.

21 DIMMER: Press to change the brightness of the front panel display or to turn the display off completely in the following order: FULL BRIGHTNESS → HALF BRIGHTNESS → OFF → FULL BRIGHTNESS

22 PROGRESSIVE SCAN/INTERLACED: Press this button to change the resolution of the Component Video Output between standard definition and progressive definition (PAL interlaced and PAL progressive; NTSC interlaced and NTSC progressive).

23 ZOOM: When a DVD or VCD is playing, press this button to zoom the picture so that it is enlarged. There are 4 steps to the zoom function, each progressively larger. Press through each of the zoom stages to return to a normal picture.

24 PLAYLIST: Press this button to change the playback order of the disc.

25 RANDOM: Press for RANDOM playback in random order.

26 A-B: Press to select section A-B and to play repeatedly.

27 V.OFF: Press to turn off video output for improved performance from audio-only discs. Press again to restore video output.

28 LIGHT: Press to illuminate remote controller.

29 NUMERIC KEYS: Select numbers by pressing these buttons.

30 REPEAT: Each press of this button changes the playback mode to repeat a chapter or track or the entire disc. A repeat icon will appear in the upper right corner of the screen indicating the current repeat mode. If the Player Information Screen is active, the changes will be displayed on screen.

31 CLEAR: Press to remove the Banner menu from the screen.

32 IR EMITTER: This small, clear button-like device sends the IR commands from the remote control to the DVD 27. To ensure proper performance of the remote control, be sure to point it toward the unit and do not cover it with your fingers when sending remote commands.

Rear Panel Connections

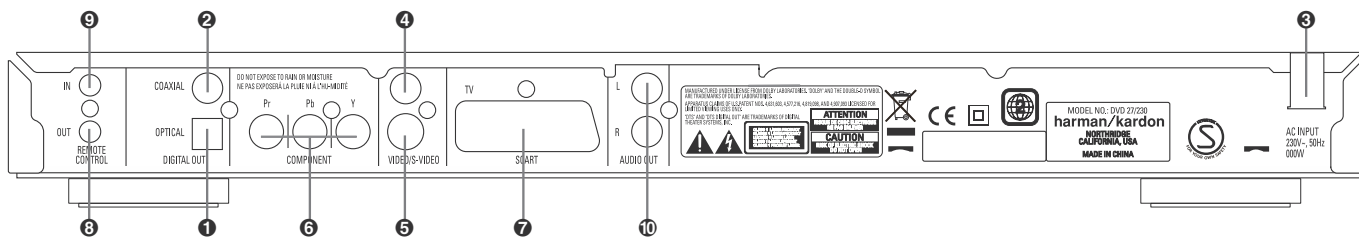

- 1 Optical Digital Output
- 2 Coaxial Digital Output
- 3 AC Power Cord
- 4 Composite Video Output
- 5 S-Video Output
- 6 Component Video Outputs
- 7 SCART TV Output
- 8 Remote Control Output
- 9 Remote Control Input
- 10 Analog Audio Output

1 Optical Digital Output: Connect this jack to the optical digital input of an A/V receiver or surround processor for Dolby Digital, DTS or PCM audio playback.

2 Coaxial Digital Output: Connect this jack to the coaxial digital input of an A/V receiver or surround processor for Dolby Digital, DTS or PCM audio playback.

NOTE: The coaxial digital output should only be connected to a digital input. Even though it is the same RCA-type connector as standard analog audio connections, DO NOT connect it to a conventional analog input jack.

3 AC Power Cord: Connect this plug to an AC outlet. If the outlet is controlled by a switch, make certain that it is in the ON position.

4 Composite Video Output: Connect this jack to the video input on a television or video projector, or to a video input on an A/V receiver or processor if you are using that type of device for video input switching.

5 S-Video Output: Connect this jack to the S-Video input on a television or video projector, or to an S-Video input on an A/V receiver or processor if you are using that type of device for S-Video input switching.

6 Component Video Outputs: These outputs carry the component video signals for connection to display monitors with component video inputs. For standard analog TV's or projectors with inputs marked Y/Pr/Pb or Y/Cr/Cb, connect these outputs to the corresponding inputs. If you have a high-definition television or projector that is compatible with high scan rate progressive video, connect these jacks to the "HD Component" inputs. Note that if you are using a progressive scan display device, then "Progressive" must be selected in the Video Setup Menu in order to take advantage of the progressive scan circuitry. See page 19 for more information on progressive scan video.

IMPORTANT: These jacks should NOT be connected to standard composite video inputs.

7 SCART OUT (TV): If your TV has a SCART socket, you can connect a SCART cable to your TV and to your DVD Player for improved video quality. The SCART cable carries both audio and video. You can select Composite Video or RGB video for that SCART connector's video output signal.

8 Remote Control Output: Connect this jack to the infrared (IR) input jack of another compatible Harman Kardon remote controlled product to have the built-in Remote Sensor on the DVD provide IR signals to other compatible products.

9 Remote Control Input: Connect the output of a remote infrared sensor, or the remote control output of another compatible Harman Kardon product, to this jack. This will enable the remote control to operate even when the front panel **Remote Sensor** on the DVD is blocked. This jack may also be used with compatible IR remote control-based automation systems.

10 Analog Audio Output: Connect these jacks to an audio input on an A/V receiver or surround processor for analog audio playback.

Note: You'll find more details about all Audio/Video connections under Setup and Connections on the following pages.

Setup and Connections

- Ensure that the power switch of this unit and other equipment to be connected is set to off before commencing connection.
- Do not block ventilation holes of any of the equipment and arrange them so that air can circulate freely.
- Read through the instructions before connecting other equipment.
- Ensure that you observe the color coding when connecting audio and video cables.

Connecting to a stereo TV and stereo or Pro Logic Amplifier/Receiver

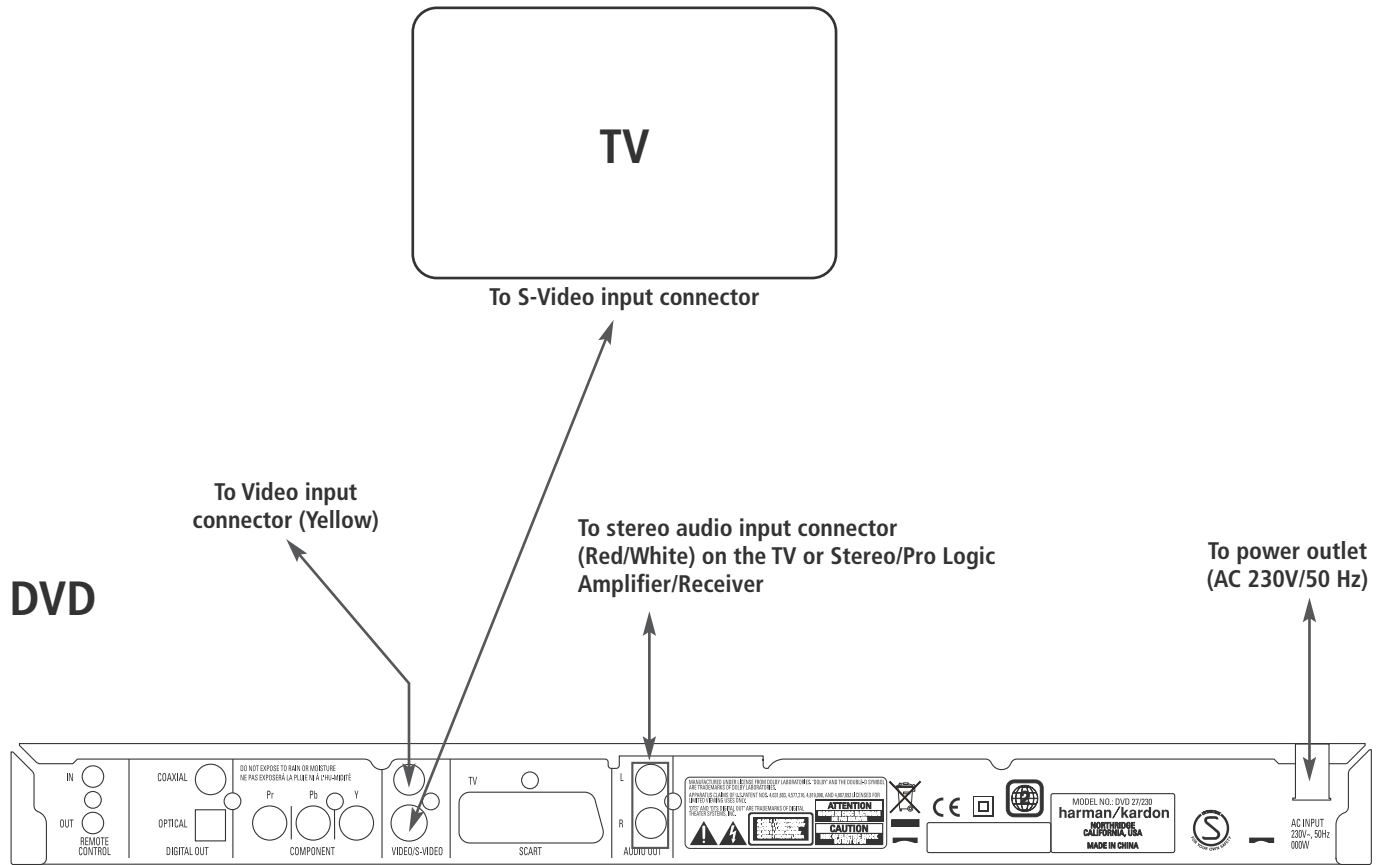

Notes:

- The Video output (yellow) combines the complete video signal (composite) and sends it to the TV (or to the AV Receiver) by one line only. Use the Video output, when your TV set is equipped with a Video input jack only.
- The S (separate) video output connector separates the color (C) and luminance (Y) signals before transmitting them to the TV set in order to achieve a sharper picture. Use the S-video cable when connecting the player to a TV equipped with an S-video input for improved picture clarity. Never connect both outputs, Video and S-Video, to your TV or AV Receiver, only one of them.
- Most European TV's are equipped with SCART connectors rather than with a normal video input (yellow cinch). In that case the SCART connection should be used, providing the audio signal too. Separate analog audio connections to TV are needed only if your TV is connected to the video or S-video output.
- When the audio signal is to be fed to a stereo or Pro Logic amplifier/decoder or receiver rather than to the TV, connect the Audio Out jacks to any normal audio input on your amplifier/decoder/receiver. The DVD will "downmix" Dolby Digital recordings to Pro Logic, available on these connectors, all analog surround or stereo signals will be fed to them directly. You can also select the audio and video signals of all your video devices with your AV Receiver/Amplifier. For more information see "Note" on next page.

Setup and Connections

Connecting to a receiver/amplifier with Dolby Digital (AC-3) or DTS (Digital Theater Systems) decoder

When DVD's encoded in Dolby Digital or DTS are played, the Dolby Digital or DTS bitstream is output from the player's OPTICAL or COAXIAL digital audio output. When the player is connected to a Dolby Digital or DTS decoder, you can enjoy theater-quality audio in your home. An optical digital audio cable or coaxial audio cable (both optional) is required for these connections, as shown below. Only one connection is needed, not both at the same time.

■ **Note:** With multiple video sources, your Audio/Video device can be used for selecting the video signal and routing it to the TV. Connect the video or S-video output of the DVD player (whatever is provided with your device) to the video or S-video input on your device and the video/S-video output of this device to your TV. For more details, see the manual of your Audio/Video amplifier/receiver.

■ **Note for Analog Audio:** The connection from Audio Out to the TV is optional only. Normally you'll hear the sound from your AV-system's speakers, so the TV volume should be completely turned down. If you plan to use your DVD player also without having to turn on your complete system, this connection must exist, then you can turn up the TV's volume as needed.

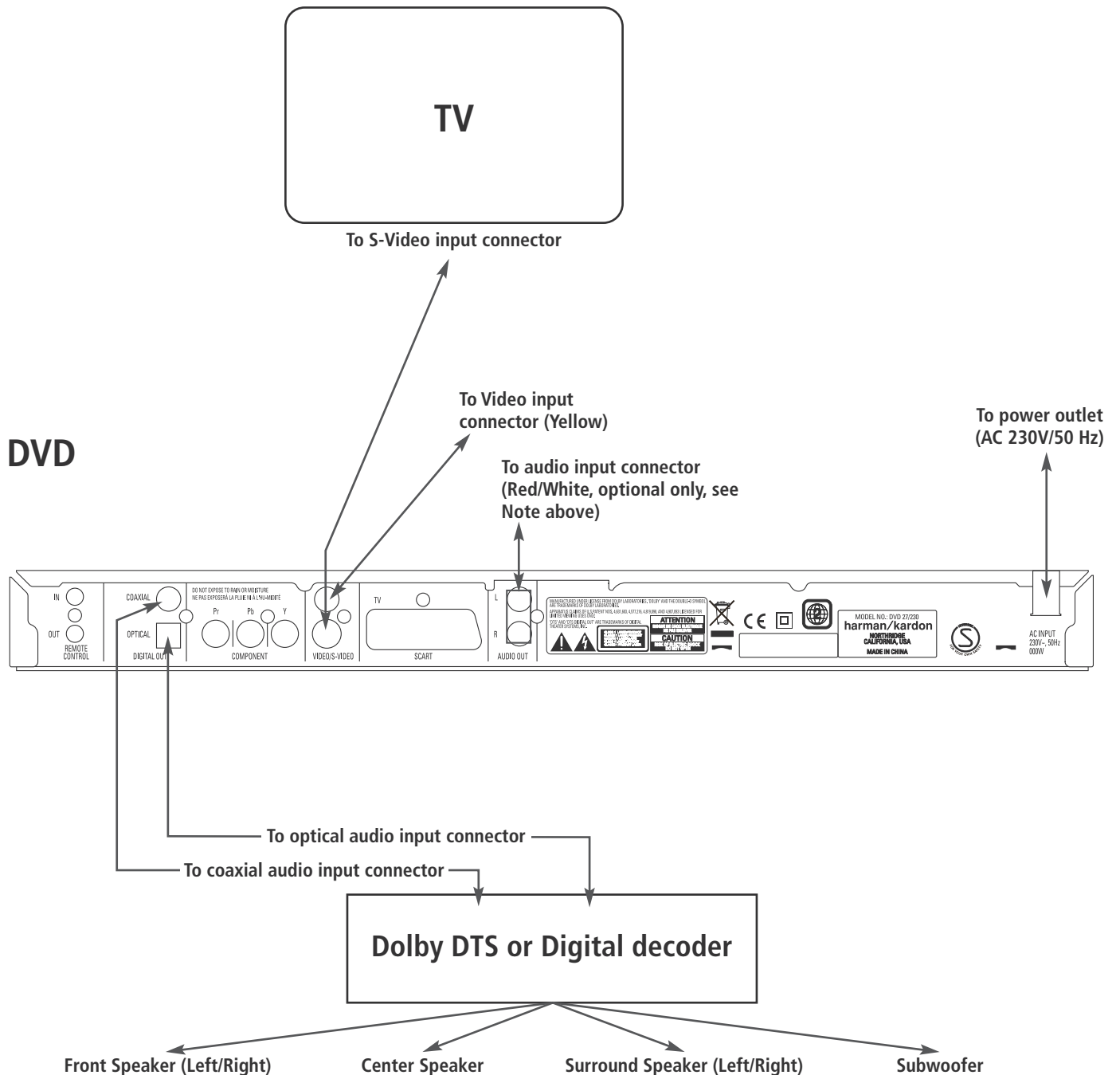

Setup and Connections

Connecting to a TV or monitor with SCART or Component connectors.

Important Notes on SCART and RGB format:

- Your DVD is equipped with a SCART connector for direct connection to the TV.
- The SCART connector provides the video signal as well as audio (stereo L/R) signals.
- The SCART connector for the TV provides the composite video signal or the direct RGB signal, delivering the best video performance possible, selectable in the Setup menu. To view RGB video on your TV, the RGB compatible SCART connector on the TV must be used and the DVD's TV SCART connector must be set to "RGB".

Note that with RGB video the color intensity cannot be adjusted with most TVs.

- When the RGB video signal is used, DVD's recorded with the NTSC format (with regional code 0 or 2) can be viewed even on non-NTSC compatible TVs.

Component Video Connection

If the video display has component video inputs, connect the Component Video Outputs on the DVD to the corresponding input jacks on your television. If you are using a progressive scan television or projector, you must also change the Scan Type in the DVD player's Video Set-Up Menu from "Interlaced" to "Progressive".

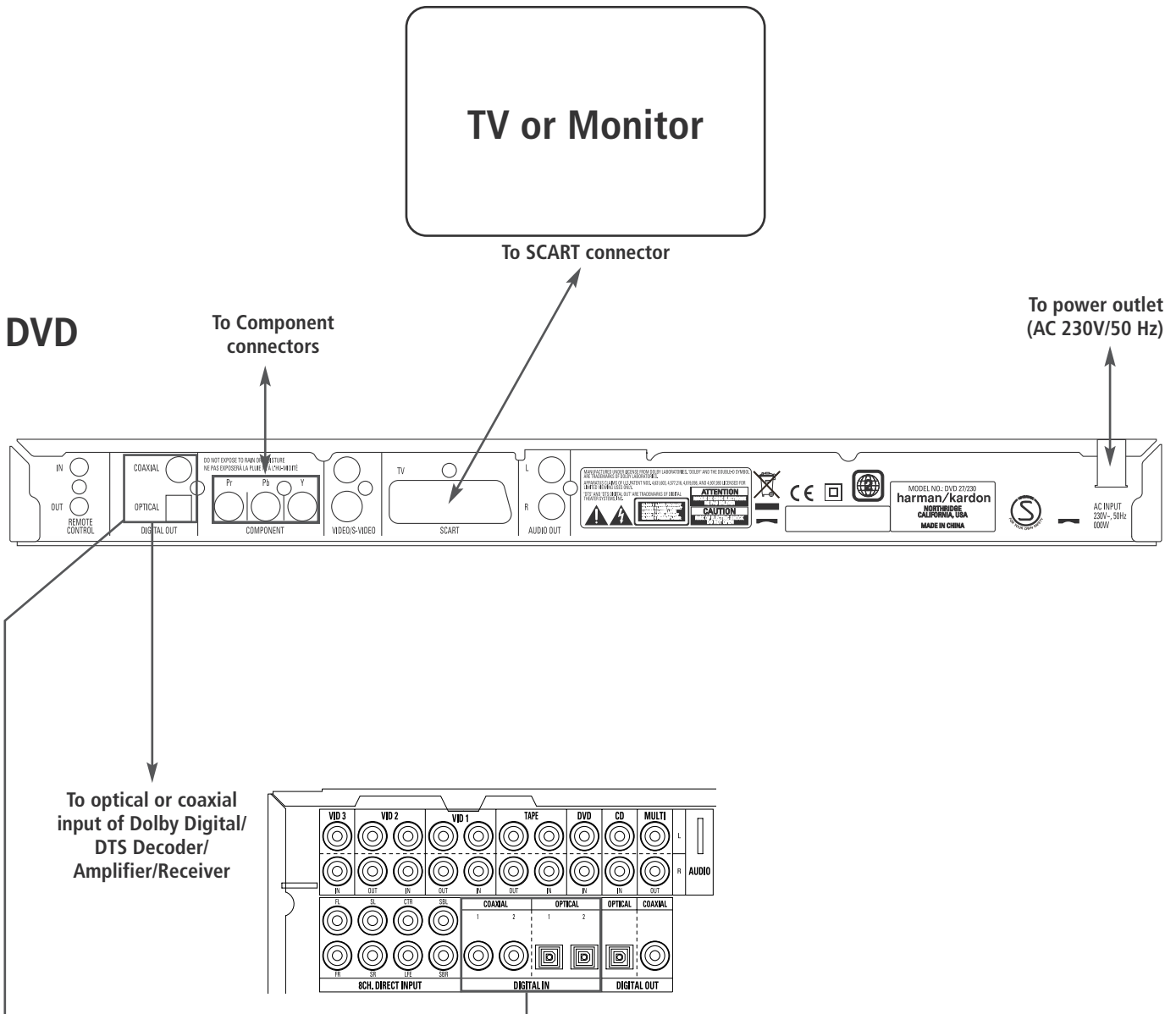

Remote Control

Battery installation

Insert the batteries supplied while observing the correct (+) and (-) polarities.

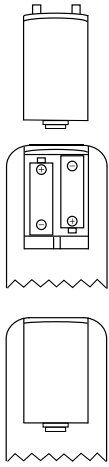

Service life of batteries

- The batteries normally last for about one year, although this depends on how often, and for what operations, the remote control is used.
- If the remote control unit fails to work even when it is operated near the player, replace the batteries.
- Use size "AA" batteries.

Notes:

- Do not attempt to recharge, short-circuit, disassemble, heat or throw the batteries into fire.
- Do not drop, step on or otherwise impact the remote control unit. This may damage the parts or lead to malfunction.
- Do not mix old and new batteries.
- Wipe away any leakage inside the remote control unit, and install new batteries.
- If leakage should come into contact with parts of your body, wash it off thoroughly with water.
- Batteries contain chemical substances and we recommend that you dispose of them properly and in compliance with any local regulations. Do not simply throw them away but return to your dealer or special battery disposal centers.

Remote control operation range

Point the remote control unit from no more than about 7 m from the remote control sensor and within about 60 degrees of the front of the unit.

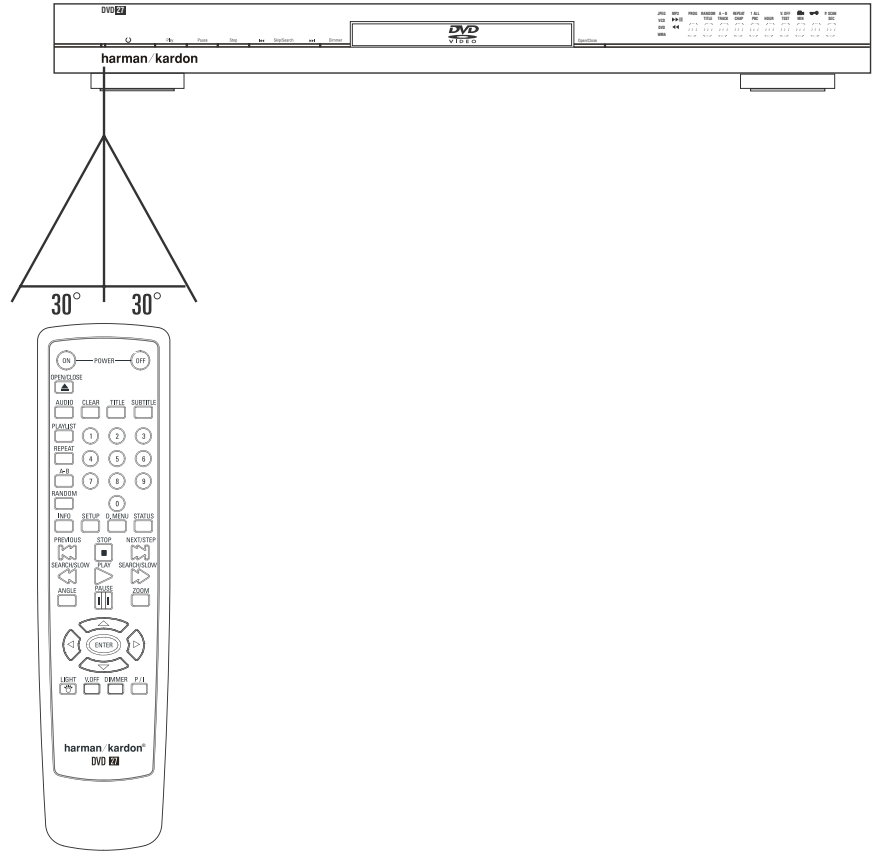

- The operating distance may vary according to the brightness of the room.

Notes:

- Do not point bright lights at the remote control sensor.
- Do not place objects between the remote control unit and the remote control sensor.
- Do not use this remote control unit while simultaneously operating the remote control unit of any other equipment.

Digital Audio Connections

Audio output from the unit's optical/coaxial digital audio output connector

Disc:	Sound recording format:	Optical/coaxial digital audio output:
DVD	Dolby Digital	Dolby Digital bitstream (2-5.1ch) or PCM (2ch, 48kHz, 16-bit)††
	Linear PCM (48/96kHz, 16/20/24-bit)	Linear PCM (2ch) (48/96kHz, 16/20/24-bit)
	DTS	Bitstream or no output*
	MPEG (2.0)	MPEG bitstream (2ch) or linear PCM (2ch, 48kHz)
VCD	MPEG-1 CD-DA	Linear PCM*
CD	Linear PCM	Linear PCM (44.1kHz sampling)
	MP3 MPEG-1 Audio Layer 3)	Linear PCM (44.1–48kHz, depending on source, if digital output format selected as "Bitstream"). (48kHz if digital output format selected as "PCM")
	WMA (Windows Media Audio)	Linear PCM (32–48kHz)

* Digital Format must be selected as "ORIGINAL" or "PCM" respectively in Menu

For your reference:

- Dolby Digital (AC-3) is a digital sound compression technique developed by the Dolby Laboratories Licensing Corporation, supporting 5.1-channel surround sound, as well as stereo (2-channel) sound, this technique enables a large quantity of sound data to be efficiently recorded on a disc.
- Linear PCM is a signal recording format used in CDs. While CDs are recorded in 44.1 kHz/16 bit, DVDs are recorded in 48 kHz/16 bit up to 96 kHz /24 bit.
- If you have a Dolby Pro Logic Surround decoder connected to the DVD's analog AUDIO OUT connectors, thanks to the "Downmix" function of the DVD you will obtain the full benefit of Pro Logic from the same DVD movies that provide full 5.1-channel Dolby Digital soundtracks, as well as from titles encoded with Dolby Surround.
- The DVD is designed to digitally output 96 kHz-PCM audio with a 96 kHz sampling rate. However, some 96 kHz DVD's may include copy protection codes that do not permit digital output. For full 96 kHz fidelity from these discs, use the analog outputs of the DVD.

IMPORTANT: If your surround processor/D/A converter does not support 96 kHz PCM audio, you must use the DVD analog outputs for full 96 kHz fidelity with these discs.

Caution for the optical/coaxial digital audio outputs:

- When connecting an amplifier (with an optical/coaxial digital input) which does not contain a Dolby Digital (AC-3) or DTS decoder, be sure to select "PCM" as initial setting in the "Digital Output" menu (see also page 18).
Otherwise, any attempt to play a DVD may cause such a high level of noise that it may be harmful to your ears and damage your speakers.
 - CD's can be played as they would normally be played.
- Note:**
- Some first generation DTS decoders which do not support DVD-DTS interface may not work properly with the DVD/CD player.

Notes when connecting the optical digital audio cable (optional)

- Gently push the cable plug through the built-in shutter that covers the optical digital audio output and connect the cable firmly so that the configurations of both the cable and the connector match.

Dolby Digital and DTS

Both Dolby Digital and DTS are audio formats used to record 5.1-channel audio signals onto the digital track of film. Both of these formats provide six separate channels: left, right, center, left rear, right rear, and common subwoofer. The latest 6.1-formats, Dolby Digital EX and DTS ES, even one (or two) additional "Surround Back" channel for a center between the rears.

Remember, that Dolby Digital or DTS will only play 5.1-channel sound if you've connected the optical or coaxial output of the DVD player to a DTS or Dolby Digital receiver or decoder and if the disc was recorded in the Dolby Digital or DTS format.

Dolby Digital is a trademark of Dolby Laboratories Licensing Corporation.
Manufactured under license from Dolby Laboratories. "Dolby" and the double-D symbol are trademarks of Dolby Laboratories.
Confidential Unpublished Works. 1992-1997
Dolby Laboratories, Inc. All rights reserved.
DTS is a registered trademark of Digital Theater Systems.

Playback Basics

Basic Play

Preparation

1. Switch the TV ON and select its video input connected to the DVD.
2. Press POWER to turn on the unit, the DVD harman/kardon logo should appear now on the screen. If that logo appears distorted on the screen or without any color, change the appropriate settings at the Video Setting Sub-menu according to your TV set and to the connection used between the DVD and your TV.
3. When you see no video at all, not even the harman/kardon logo, check the setting of the video input used on your TV (most SCART inputs on TVs can be configured in the TV's menu). When you don't succeed, connect your TV with different cables to the DVD, e.g. via Composite (yellow jacks) or S-Video cables, rather than per SCART to view the setup menus until all appropriate "Video menu" settings are made properly.
4. Switch on your A/V system's power, if the player has been connected to such a system.
5. Press OPEN/CLOSE to open the disc tray.
6. Place a disc on the disc tray.

Hold the disc without touching either of its surfaces, position it with the side you wish to play facing down, align it with the guides, and place it in its proper position.

■ 3" (8 cm) discs or 5" (12 cm) discs can be used.

7. Press PLAY. The disc tray is automatically closed and play begins.

■ When the disc tray is closed by pressing OPEN/CLOSE, play will start automatically.

■ With most DVD's, a Disc Menu appears on the screen. Select specific menu item by using ARROW buttons on the remote, then press ENTER.

Disc Playback Features

Skipping tracks or titles/chapters

To move forward or backward through the tracks on a CD or the titles or chapters on a DVD, press skip on the front panel or Previous/Next on the remote.

Fast Motion Playback/Fast Search

1. To move forward or backward through the DVD or CD disc being played at fast speed, press SEARCH on the remote. Once one of these buttons is pressed, the fast search will continue until PLAY is pressed.

There are four fast-play speeds. Each press of the SEARCH Buttons will cycle to the next speed in the following order: x2, x4, x8, x20, x100, indicated by a number of arrow indicators on the right top of the screen.

2. Press PLAY at any time to resume normal playback.

Note that there will be no audio playback during fast-forward or -reverse play of DVD discs. This is normal for DVD, as A/V receivers and surround processors cannot process the digital audio streams during fast-play modes; audio will be heard during fast-play of conventional CD's.

Freeze Frame and Frame Advance (with DVD only)

1. Press PAUSE when a DVD is playing to freeze the picture.
2. Each time you press one of the STEP (FWD or REV) buttons, the picture advances one frame.
3. Press PLAY to resume normal playback.

Slow Motion Playback (with DVD only)

1. When a DVD disc is in pause or freeze frame mode, you may move slowly forward or backward through the program being played at one of the speeds by pressing the Play Buttons on the remote. Each press of the buttons will move to the next speed, indicated by a number of arrow indicators on the right top of the screen.
2. Press PLAY to resume normal playback.

Note that there will be no audio playback during slow-forward or -reverse play of DVD discs. This is normal for DVD, as A/V receivers and surround processors cannot process the digital audio streams during slow modes. Slow play is not available for CD.

Notes: Playback features may not be available during the opening credits of a movie. This is intended by the disc author and is not a failure of the DVD.

Playback of a DVD with 96 kHz/24-bit audio requires the use of circuitry normally used for other features. Accordingly, Slow Play Reverse and Step Advance features are not available with these discs.

Depending on the structure of a VCD disc, the functions Slow Reverse and Step Reverse may be prohibited or have no function and Fast Playback (Search) may not function.

About DivX Movie Files

The DivX disc compatibility of this DVD player is limited by the following:

- the available resolution size of the DivX file should be below 720x576 (W x H) pixels.
- the total number of files and folders on the disc should be less than 999.
- the number of screen frames per second should be below 29.97 frames per second.
- the video and audio structure of recorded file should be interleaved.

The player is capable of playing DivX files with the extensions ".avi".

The player is capable of playing subtitle files with the extensions ".smi", ".srt", ".sub (Micro DVD format only)" or ".ssa". Other subtitle files won't be displayed. Subtitle files need to carry the same name as the movie file (but with either one of the above extensions) and should be located in the same directory.

Playing a DivX Movie Disc

Before playing DivX movie discs, please note the following:

- multi session DVD containing Windows Media Audio files may not be supported.
- open session discs are not supported.
- the DVD player does not support PC data.
- this DVD player does not support an unfinalized disc with a closed session.

1. Insert a disc and close the tray.
2. Press the OSD button of the remote control and select a folder by pressing the up/down cursor buttons and press ENTER. A list of files in the folder appears. If you are in a file list and want to return to the Folder list, use the up/down buttons on the remote to highlight and press ENTER.
3. If you want to view a particular file, press the up/down buttons to highlight a file and press PLAY.

When playing back a DivX movie you can use variable playback functions like fast and slow backward and forward, as well as step forward and step backward.

4. Press STOP to stop the playback.

The DVD player's playback functionalities of DivX video discs will vary depending on the DivX version used for creating your movies.

System Setup

System Defaults

The final step of the installation is to establish the system's defaults. It is helpful to take a few minutes to familiarize yourself with these settings, as they may require change before the first use and later from time to time.

General Functionality of the OSD Menu

The complete setup and control of the DVD 27 takes place in an advanced user-guided On Screen Display (OSD) menu system. The OSD can be activated by pressing the SETUP button on the remote control. Pressing this button again deactivates the OSD.

The main menu consists of a PLAYER INFORMATION Menu and a SET-UP Menu. The PLAYER INFORMATION Menu will show all information and options available for the disc currently playing. The SET-UP Menu will help you configure all audio and video settings which are normally only made once.

Each Main Menu contains Submenus. These submenus are shown as icons on the left side of the menu. They can be highlighted by a white square around the icon by moving the cursor with the ARROW buttons. Icons can be activated by pressing ENTER as soon as an icon is highlighted. When ENTER has been pressed, the color of the icon will change to dark blue and you will see that the Actual Settings of this submenu will appear on the right side of the menu.

Although each Menu has various Submenus and Settings, navigating through menus, submenus and settings goes the same way. All submenus, settings and options can be accessed with the help of the ARROW (▲▼▶◀) and ENTER buttons on the remote control.

To change a setting, simply move the cursor to the setting you wish to change. This setting will be highlighted in light blue, and a brief explanation will appear in the Instruction Line on the bottom of your screen.

Next, press the **Enter Button 7** and a drop-down menu will appear that contains the available options for that setting. Press the **▲▼ Navigation Buttons 10** until the desired option is highlighted, then press the **Enter Button 7** to select that option.

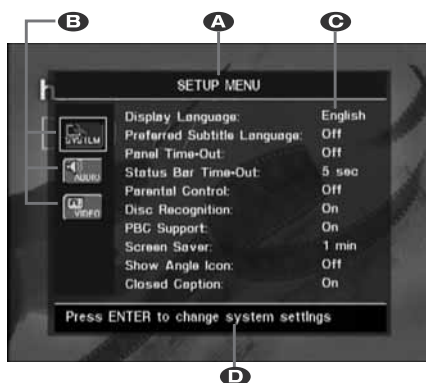

- A** Main Menu Line
- B** Submenus
- C** Actual Settings
- D** Instruction Line

Most DVDs are created to allow setup menus to be displayed while the disc is playing, superimposed over the video playback. However, some discs are authored in a way that does not allow this. If you see the  icon displayed on the screen after pressing the **Setup Button 9** or the **Info Button 11**, press the **Stop Button 19** and then press the **Setup or Info Button 9 11** again.

Set Up Menu

The first step in checking or changing the system defaults is to access the Setup Menu. First, make certain that the DVD is properly connected to a video display, and that power is connected. For this process, however, you do not need to load any discs into the unit.

During STOP, PAUSE or PLAY mode, if you press SETUP on the remote, the Set Up Menu appears on the screen.

This Main Menu and all menus in the following section may look different, listing the settings with different languages, depending on the settings made previously. With the factory default setting all languages are set to "English", that's why with all menus the English version is shown in the manual.

In the SET-UP Menu you will find submenus for making or changing all settings and adjustments for both Audio and Video handling of your DVD 27.

System Setup

System Settings



The System Setting Submenu contains the following settings. Follow the explanations in the Instruction Line on the bottom of your screen to change the settings.

Display Language: Sets the language in which the OSD menus are shown on your screen.

Preferred Subtitle Language: Defines your preferred subtitle language. Every time a disc will be played that contains this subtitle language, it will be shown automatically. If you do not find your preferred language in the list of options, you can select your preferred language by highlighting OTHER. Press ENTER and use the Navigation Buttons to select your preferred language from the list shown on the screen. Note that only those languages will be available that are actually on the DVD you would like to play. You can also set the preferred subtitle language to OFF. In that case no subtitles will be shown.

Panel Time-Out: Sets the time-out interval for the Front Panel Information Display. After the selected time, the display will dim completely.

Status Bar Time-Out: Sets the time-out interval for the Status Bar, after which the Status Bar will disappear from the screen.

Parental Control: Defines a password used to control viewing of restricted programs. The default password is 1234. After pressing the default password, either the parental control setting can be chosen, or a new password. The five standard US rating symbols are "G" (General, level 2), "PG" (Parental Guidance, level 4), "PG13" (Parental Guidance and 13 years old, level 4), "R" (Restricted, level 6) and "NC 17" (from 17 years old, level 7). The DVD will accommodate a total of eight rating steps, as set by the DVD creators. These additional steps allow for more critical control of program playback for all audiences. Level 8: All DVDs can be played. Levels 7 to 2: DVDs for general audiences/ children can be played. Level 1: DVDs for children can be played; DVDs for adults/general audiences are prohibited. Follow the explanations on the screen to set a new password.

Disc Recognition: This setting controls the Disc Recognition feature. When turned on, it allows you to pause a DVD, remove it from the player, play another disc, and then resume playback of the original disc at a later time from the

point at which you paused. Note that even when the setting is activated, you must pause playback, rather than bring it to a full stop, and the unit must not be turned off between discs. The DVD 27 is capable of storing the information for up to five DVDs at a time.

PBC Support: Activates PBC (Play Back Control) Support for VCD discs.

Screen Saver: Activates a Screen Saver to prevent an image to "burn" into a video display device. If you connect the DVD 27 to a LCD or plasma screen or video projector, we recommend you activate the screen saver at all times.

Show Angle Icon: Determines whether the Angle Icon will appear on the screen when there are different angles available on a DVD disc.

Closed Caption: This setting enables viewing of closed caption messages, if they have been encoded in the video material. Closed captions are text displays of the program's dialogue, normally hidden from view, that are made available for the hearing-impaired or others. Select the ON setting to activate the DVD 27's closed captioning decoder so that these messages may be viewed.

Audio Settings



The Audio Setting Submenu contains the following settings. Follow the explanations in the Instruction Line on the bottom of your screen to change the settings. In case the audio settings have been changed, they will take effect after the next time the player goes through STOP mode.

Preferred Audio Language: Defines your preferred audio language. Every time a disc is played that contains this audio language, it will be activated automatically. If you do not find your preferred language in the list of options, you can select your preferred language by highlighting OTHER. Press ENTER and use the Navigation Buttons to select your preferred language from the list shown on the screen. Note that only those languages will be available that are actually on the DVD you would like to play.

Digital Output: If your system includes 5.1 digital audio surround decoding (Dolby Digital and/or DTS), select BITSTREAM as the digital output. In that case all audio signals will be output with their original format. If your system only

includes stereo and/or Dolby Pro Logic, select PCM. Then all audio signals will be output in PCM format only (DTS will output no signal).

PCM Limit: The DVD 27 is compatible with both 48 kHz and 96 kHz sampling, but some early A/V receivers and surround processors are not. If your A/V receiver or surround processor is NOT capable of handling 96 kHz signals, select the 48 kHz option. If your A/V receiver or surround processor IS capable of handling 96 kHz signals, select the 96 kHz option to achieve the greatest audio fidelity available.

Note: Due to copyright restrictions, the DVD 27 will not output an uncompressed signal in the PCM format from a disc recorded with 96kHz/24-bit resolution, such as some DTS audio CDs. If the Digital Output setting in the AUDIO SETUP submenu is set to PCM, and the PCM Limit setting is set to 96KHZ, no audio will be outputted, and the message CGMS MUTE will appear in the Main Information Display. "CGMS" stands for "Copy General Management System." Should this message appear, change the PCM Limit setting to 48KHZ to hear the audio at a lower resolution.

Dynamic Range: This setting allows you to take advantage of the programming present on some Dolby Digital recordings to reduce the volume of louder passages while maintaining intelligibility of quieter passages. This means that you may listen to programs at a level that allows the full impact of a soundtrack to be heard at a volume that is lower than you might otherwise use to avoid disturbing others. The DVD 27 accomplishes this by compressing the audio to a greater or lesser degree, depending on which setting you choose. Three options are available:

- **MINIMUM** does not make any changes to the original playback, and should be used when the volume setting in the listening room may be as loud as you desire.
- **MEDIUM** applies a moderate amount of compression so that louder passages are a little bit quieter.
- **MAXIMUM** applies more compression so that louder passages are much softer.

Feel free to experiment with the settings at any time. Note that if your receiver or processor also allows you to program the dynamic range setting, also known as the "Night Mode," you do not need to make any adjustments on the DVD 27 and should leave the setting at **MINIMUM**.

System Setup

Video Settings



The Video Setting Submenu contains the following settings. Follow the explanations in the Instruction Line on the bottom of your screen to change the settings.

Aspect Ratio: This step selects the TV aspect ratio, conventional screen shape (4:3) or widescreen (16:9), according to your TV.

Video Standard: Sets the output video format i.e. NTSC, PAL or SECAM, of the DVD player. If you have a multi standard TV, we recommend the AUTO setting for optimal picture quality.

Video Output: Sets the video output type to S-Video, Component or SCART. Scart will be used for most TV's. Component will be used for most LCD, Plasma and projectors.

Scan Type: Sets the video output to Interlace or Progressive. Before changing the setting to Progressive, make sure that your video display is capable of handling progressive scan signals. As soon as you select progressive scan the scan type, the Video Output will automatically change to Component. The Progressive Scan output is available on the YUV/Component output only.

NOTES:

1. The Scan Type may only be changed when the Video Output setting has been set to Component.
2. If you have connected the DVD 27 to a video display that is not capable of displaying progressive scan video using the Component (Y/Pr/Pb) **Video Outputs 4**, and you have inadvertently changed the Video Output Setting to Component and the Scan Type setting to Progressive, you may reset the scan type to interlaced by pressing the **Progressive Scan/Interlaced Button 22**. The display will blink, indicating that the scan type has been reset to interlaced mode.

Scart Output: Selects which kind of video output signals will be routed over the scart. RGB will be used for most TV's and is therefore recommended.

Video Adjustment: The Video Adjustment Submenu contains access to the Test Screen. First adjust the video display device (TV) with the help of the Test Screen. After that the output settings of the player can be fine-tuned with the Brightness, Sharpness and Black Level settings. In order to change the settings, move the cursor to the "+" or "-" icon on the same line as the setting. Once one of the icons is highlighted, pressing ENTER will increase or decrease the value of the setting, as will be shown in the bar behind the setting. To exit the Video Adjustment Menu, move the cursor to DONE, and press ENTER.



DivX Subtitle: This setting selects the desired subtitle language for DivX movies.

Below the menu items you will find your personal DivX Video On Demand (VOD) code.

This code allows you to rent and purchase videos using the DivX VOD service. For more information, visit www.divx.com/vod. Follow the instructions and download the video onto a disc for playback on this unit. Note that all the downloaded videos from DivX VOD can only be played back on this unit.

Once the DivX icon is highlighted, press ENTER to access your personal DivX VOD code.

Test Screen

Test Screen

When you activate the Test Screen via the OSD you can activate a still image to test all settings and the video performance of your TV. With the vertical color bars you can test the following:

- proper color intensity setting on your TV,
- the proper color of each bar, showing if the proper video standard is turned on: the colors should be (left to right): black, white, yellow, cyan (turquoise), green, magenta (purple), red, blue, black.
- proper color transition, seen as sharp separation of the bars, S-Video will be better than Video, RGB best of all.
- the performance of the color filter in your TV (with "Video" signals), bar edges should show no vertical crawling dots. Here S-Video and RGB formats usually give no problems.

With the grey scale and the black/white fields below the color bars the brightness and contrast of your screen can be adjusted optimally, see chapter "TV Picture Adjustment" below.

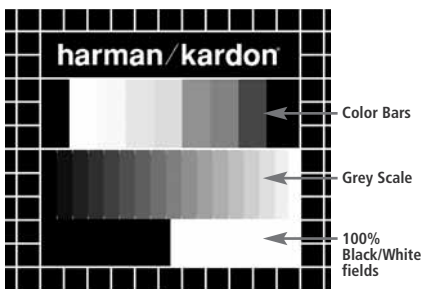

TV Picture Adjustment with Test Screen

These adjustments may be done now, but you can also make them after setup has been finalized.

Brightness adjustment:

1. Turn down the color control on your TV until the color bars are visible in black and white.
2. Adjust the contrast to the lowest level where you still can see all bars within the grey scale in the test picture separately and clearly.
3. Adjust the Brightness so that the bars in the grey scale are all visible. The bar furthest to the left has to be as black as possible rather than grey but the next aside must clearly be differable. All the bars in the grey scale have to be gradually and evenly changing from black to whiter, going from left to right.

Contrast adjustment:

1. Adjust the contrast on your TV until you see a bright white bar in the right low corner of the screen and a deep dark black bar at the left. The optimal contrast setting will depend from your preference and the surrounding light in the TV room.
2. If the brightness of the white bar will no more increase while turning up the contrast or when the borders of the white "harman/kardon" text letters on top will bloom (overlight) into the black areas, what drastically will decrease the sharpness of the script, then the Contrast has been turned up too much. Reduce the contrast until these effects will disappear and the video still looks realistic.
3. If you are watching TV with a usual surrounding daylight, adjust the Contrast so that a normal video picture has about the same looking as the surroundings in your room. By that way the eye is relaxed when watching the TV picture. This contrast setting may be reduced when the surrounding light is dimmed, usually improving the sharpness of a video a lot thereby.
4. The grey scale in the middle line needs to have the same clear difference between each bar as before the contrast adjustment. If not, go back to the brightness adjustment and repeat step 3 and then the contrast adjustments, making only minor adjustments each time for optimisation.

Color adjustment.

1. When the Brightness and the Contrast are set optimally, turn up the color control to the level of your preference. Adjust to the level where the colors look strong but still natural, not overdone. If the color level is too high, depending from the TV used some of the bars will seem wider or the color intensity will not increase while the control is turned up. Then the color control must be reduced again. At the end you should test the color intensity also with a video, e.g. pictures of natural faces, flowers, fruit and vegetables and other well known natural articles of our life most usefull for an optimal setting of the color intensity.
2. If your TV has a Tint option (with most European TVs this is available or effective only with NTSC signals, not with PAL), use the large white bar below the Greyscale to tweak the warmth of the picture. Every viewer has a difference in preference as how the glow of the picture should be. Some prefer a little colder picture, some a warmer glow. The Tint function on your TV and the white bar can be used to control this. Adjust the Tint to the level where you feel the white color has the tone you prefer.

Sharpness Adjustment

Contrary to intuition, the picture will appear sharper and clearer with the sharpness, or Edges, setting backed off from the maximum setting. Reduce the sharpness setting on your television, and the Edges setting on the DVD 27 video adjustments menu if necessary, to minimize the appearance of any white lines between the bars in the gray scale portion of the test screen.

Convergence and Edge Focus

The crosshatch pattern that surrounds the test screen may be used to evaluate edge focus and convergence in front- or rear-projection video displays. However, the controls used to adjust these parameters are often not user-accessible. In any event, these adjustments are extremely complex, and require proper training and experience to avoid worsening the situation. Therefore, it is recommended that if you are unable to improve the picture using the available controls, contact the video display manufacturer's authorized service representative for assistance.

When all desired setup and configuration entries have been made, use the ▲ ▼ **Navigation Buttons** 10 until "Done" is highlighted at the bottom of the Video Adjustments submenu. Press the **Enter Button** 7 to select it to return to the on-screen menu system. Then, press the **Setup Button** 9 to remove the menu displays from the screen. The unit will return to normal operation and you are ready to enjoy the finest in DVD or CD playback!

Player Menu

Using the Player Information Menu

The DVD 27's Player Information menu displays disc information and enables you to program playback modes. Press the **Info Button** **11** to display the Player Information menu.



The Player Information menu has two submenus which may be accessed by using the **▲▼ Navigation Buttons** **10** to highlight the submenu's icon, and pressing the **Enter Button** **7** to select it. These submenus are different from the Setup menus in that many items are for display only and cannot be changed using the menu system.

Navigation Buttons **10** to highlight the submenu's icon, and pressing the **Enter Button** **7** to select it. These submenus are different from the Setup menus in that many items are for display only and cannot be changed using the menu system.

PLAYBACK INFO Submenu: This submenu displays basic disc and playback mode information. You may not make any changes to the items shown in this submenu, except for the Repeat mode.

- **Disc:** This line displays the disc type, such as DVD-Video.
- **Disc ID:** If the disc is encoded with an identification label, such as a movie title, it will appear here.
- **Playlist:** For DVDs, this line will reflect that playback will occur in the disc's order. Programmable playlists are not available when a DVD is loaded.
- **Repeat:** This line displays the current repeat mode, or Off if Repeat mode is not active.



PROGRAM submenu: The **PROGRAM** submenu is not accessible for DVDs.

DISC INFO Submenu: This submenu displays detailed information about the disc content. You will not be able to make any changes to the items on this submenu. However, you may use the **SETUP** menu system as described on page 19 to change the DVD 27 player settings for video aspect ratio or scan type.

- **Disc:** This line displays the disc type.
 - **Disc ID:** If the disc is encoded with an identification label, it will appear here.
 - **Aspect Ratio:** This line displays the aspect ratio of the video content on the disc, and the format in which it is being played back according to the setting established in the **VIDEO SETUP** submenu as shown on page 19. Some discs may contain two versions of the same program with a widescreen aspect ratio on one side of the disc, and a standard aspect ratio on the other.
 - **Video Standard:** The disc's format is shown here. For Region 2 players, this will normally be PAL, although some DVDs that are open region (playable in all regions) may be in the NTSC format.
 - **Scan Type:** This line displays whether the video program on the DVD was recorded with a progressive or interlaced scan rate. It also displays how the program is being played back, based on the setting established in the **VIDEO SETUP** submenu as shown on page 19.
 - **Audio Resolution:** This line displays the sample rate and bit rate for the current audio format.
 - **Audio Format:** This line displays the current audio track, such as Dolby Digital 5.1 or linear PCM.
 - **Video Bit Rate:** This line displays the video bit rate up to the limit of 10 Mbps. This indication will vary as a disc is played in response to changes in the amount of compression that was applied to the video signal when the disc was created. Thus, when the disc is stopped or paused, this line will remain blank.
- When you have finished viewing the Player menus, press the **Info Button** **11** to remove the displays from the screen and return to normal play.

Using the On-Screen Status Display

When a DVD is playing, you may press the **Status Button** **14** at any time to view a quick summary of the disc's playback status. The Status Bar not only gives you a snapshot of the unit's current state; it also provides an easy way to select a different title, chapter or track, or use the time search feature.



- **Title:** This displays the current title on the left, and the total number of titles on the disc on the right.
- **Chapter:** This displays the current chapter on the left, and the total number of chapters on the disc on the right.
- **Play Mode Icon:** This displays the current play mode icon: e.g. **Play** **▶**, **Pause** **||**, **Stop** **■**.
- **Time Display:** This section of the display shows the time corresponding to the type of display indicated in the **Time Display Type**. The Time Search function enables you to start playback at any point in the program. Use the **◀▶ Navigation Buttons** **10** to highlight this display, and the numbers will change to dashes. You may then use the **Numeric Keys** to enter the numbers corresponding to the time on the disc at which you wish play to commence. Press the **Enter Button** **7**, and play will immediately begin at the selected time position.
- **Time Bar:** This display is a graphic representation of the time elapsed for the title being played. As the disc plays, the number of bars will increase to reflect approximately what percentage of the title has been played thus far.
- **Time Display Type:** This section identifies the type of information in the **Time Display** section of the display. Use the **▲▼◀▶ Navigation Buttons** **10** to select this setting, and each subsequent press of the **Enter Button** **7** will change the time display from Title Elapsed, to Title Remaining, to Chapter Elapsed to Chapter Remaining, and cycle back to Title Elapsed. The time displayed on screen and in the front-panel **Information Display** **1** will change accordingly.

CD Playback

Many functions of the DVD 27 operate the same way for CD playback as for DVD play; however, there are some important differences. When a CD is loaded, the DVD 27 will automatically display the Player Information menu. Status banners are not available during CD play. A greater variety of playback options are available during CD play, including Random play and programmed playlists. These and other features unique to CD play are described in this section.

Using the Player Information Menu

The DVD 27's Player Information menu displays disc information and enables you to program playback modes. Press the **Info Button** **11** to display the Player Information menu.



The Player Information Menu has two submenus which may be accessed by using the **Navigation Buttons** **10** to highlight the submenu's icon, and pressing the **Enter Button** **7** to select it. These submenus are different from the Setup menus in that many items are for display only and cannot be changed using the menu system.

PLAYBACK INF **◊** **Submenu:** This submenu displays basic disc and playback mode information.

- **Disc:** This line displays the disc type, such as CDDA (Compact Disc Digital Audio).
- **Audio:** This line displays the type of audio recorded on the disc, usually Stereo.
- **Playlist:** For CDs only, you may choose to play the tracks in order as they appear on the disc, or you may program a playlist containing some or all of the tracks in the order in which you wish to hear them. This line indicates which of these two modes has been selected. In order to change this setting, you will need to access the **PROGRAM** submenu as described below.
- **Repeat:** With this line highlighted, press the **Enter Button** **7** to activate Repeat mode. Each press will change the repeat mode from Repeat 1 (to repeat one track) to Repeat All (to repeat all tracks on the disc) to Repeat Off.
- **Random:** With this line highlighted, press the **Enter Button** **7** to activate Random mode. Each press will toggle between turning the Random play on or off.
- **Track:** This line displays the current track on the left, and the total number of tracks on the

disc to the right.

- **Play Mode Icon:** This icon will appear to the right of the Track display and will indicate the current playback mode.
- **Time:** This section consists of three lines:
 - **Track Elapsed:** Displays the elapsed or remaining time of the current track.
 - **Disc Elapsed:** Displays the elapsed or remaining time of the disc.
 - **Elapsed Time Bar:** Displays in graphical form a temperature bar reflecting the percentage of the disc that has been played.

Use the **Navigation Buttons** **10** to highlight either Track Elapsed or Disc Elapsed, and each press of the **Enter Button** **7** will toggle between the elapsed and remaining settings. The time displayed to the right and in the front-panel **Information Display** **1** will change accordingly.

The Time Search function enables you to start playback at any point in the program. Use the **Navigation Buttons** **10** to highlight the time display. Press the **Numeric Keys** **29** followed by the **Enter Button** **7** to select a new point in the track from which to commence play.



PROGRAM Submenu: This submenu lets you program a playlist. The **PROGRAM** submenu is only accessible for CDs.

- **Disc:** This line displays the disc type.
- **Audio:** This line displays the type of audio recorded on the disc, usually Stereo.
- **Playlist:** With this line highlighted, press the **Enter Button** **7** to change the order in which the tracks are played from the order in which they appear on the disc (**Disc's order**) to a playlist order which you may program (**Programmed order**). A list of program steps and the track programmed for each step will appear at the bottom of the screen. You may enter a track number using the **Numeric Keys** **29** and then press the **Navigation Button** **10** to program another track. Use the **Navigation Buttons** **10** to select the desired program steps. Note that you may not enter a track more than once in the playlist, if it appears in an earlier step. However, you may use the Repeat function while the playlist is playing. After you have finished programming

the playlist, press the **Play Button** **4** **17** to begin play.

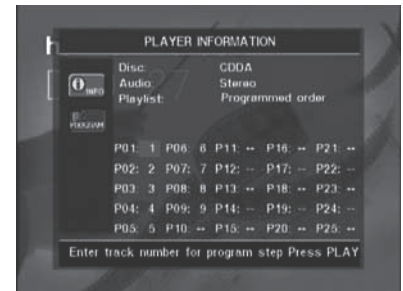

When you have finished viewing the Player menus, press the **Info Button** **11** to remove the displays from the screen and return to normal play.

Selecting a Track

To select a track, make sure the Player Information menu is on screen. Press the **Info Button** **11** to activate it if necessary. Next, press the **Navigation Buttons** **10** so that the Track Number is highlighted. Use the **Numeric Keys** **29** to enter the desired track, and press the **Enter Button** **7** to begin playing the new track.

To select a specific track on a CD at any time during playback, simply press the number corresponding to the track you wish to listen to using the **Numeric Keys** **29**. You may also move one by one through the chapters at any time by pressing the **Skip Reverse (Previous)/Skip Forward (Next) Buttons** **7** **8** **15** **16**. When you press the **Previous** **15** or **Skip Reverse** **7** button once, the player will return to the start of the current track. Additional presses of either button will step back through the available tracks, one at a time.

Note: When a JPEG, MP3 or Windows Media disc is playing, a special screen will appear.

Repeat Play

The DVD 27 offers several repeat functions for CDs that allow you to take advantage of the capacity of the unit for unattended playback:

- **Repeat Program:** Repeats the current playlist if Programmed Order has been selected at the Playlist setting.
- **Repeat 1 Track:** For CDs, VCDs, MP3s and WMAs, repeats the track or file currently being played until the disc is manually stopped. The **Repeat** and **1** indicators will light in the front-panel display, and the **REPEAT 1** icon will appear on screen.

CD Playback

- **Repeat Disc:** For CDs, VCDs, MP3s, WMAs, and JPEGs, repeats the entire disc until play is manually stopped. The **Repeat** and **All** indicators will light in the front-panel display, and the **REPEAT ALL** icon will appear in the Status Bar.
- **Repeat Folder:** For MP3s, WMAs and JPEGs, repeats all tracks within the current folder until play is manually stopped. The **Repeat** **H** indicator will light in the front-panel display, and the **REPEAT FOLDER** icon will appear on screen.
- **Repeat A-B:** Repeats any selected portion of the disc until the disc is manually stopped (see below for more information).

To select any Repeat mode (other than Repeat A-B):

While a disc is playing, press the **Repeat Button** **⏮** on the remote. The Repeat icon will appear on screen, indicating the new repeat mode. Each press of the **Repeat Button** **⏮** will cycle through the available repeat modes. To end Repeat play, continue pressing the **Repeat Button** **⏮** until the Off mode is selected.

A-B Repeat Play

The Repeat A-B function allows you to select any portion of a CD and have it repeat continually until the unit is manually stopped.

To initiate a Repeat A-B playback sequence, follow these steps while a disc is playing:

1. Press the **A-B Repeat Button** **⏮** on the remote when you want to choose the beginning point; the Repeat icon appears in the upper right corner of the screen, followed by **A -** to indicate the beginning of the passage to be repeated.
2. Press the **A-B Repeat Button** **⏮** again to choose the end point. Repeat A-B has been set, and the A-B section will be played continuously.
3. Press the **A-B Repeat Button** **⏮** on the remote again to cancel Repeat A-B mode.

Random Play

The Random Play function will play all of the tracks on a CD in a random order, as selected by the DVD 27. Once the DVD 27 has played all of the tracks on the disc once, it will stop.

You may select the random mode by pressing the **Random Button** **⏮** on the remote. Each press of the **Random Button** **⏮** will toggle the setting between "Off" and "On", meaning that the remaining tracks on the disc will be played in random order.

The **Random Indicator** **J** in the **Front-Panel Information Display** **1** will light any time the Random setting is on.

Video Off Feature

During CD playback, some listeners may prefer to turn off the DVD 27's video circuitry. Although the video section is electrically isolated from the audio section, some users may prefer to turn the video displays off during audio playback to prevent any possibility of interference between audio and video. You may also wish to turn the video display off if you find the menu system distracting or unnecessary during CD playback.

IMPORTANT NOTE: It is strongly recommended that plasma video display owners use the Video Off feature to avoid burn-in.

To turn the video displays off while a CD is playing, simply press the **Video Off Button** **⏮**. Press the button again to restore the video output. The **V-Off Indicator** **G** will light to remind you that the video displays have been turned off. Note that the video output will automatically be restored each time the DVD 27 is turned on.

MP3, Windows Media and JPEG Playback

MP3, Windows Media and JPEG Playback

The DVD 27 will recognize data from CD-ROM discs recorded in the MP3, Windows Media 8 (WMA) or JPEG formats, including images stored on Kodak Picture CDs. You may also play discs with more than one of the three formats.

The Specific File Types That May Be Played on the DVD 27 Are:

- **MP3 Files:** MP3 is a popular audio compression format that was developed by the Motion Picture Experts Group as part of the MPEG-1 video compression format. Depending on the specific MP3 encoder used, file size is greatly reduced so that you store many more songs on one compact disc than in the standard audio CD format. MP3 is also used to download audio files to computers for home use. Note, however, that in order to play an MP3 file on the DVD 27, the disc may not contain any encryption or coding that prevents playback. Always be certain that you have, or have purchased, the proper rights or authorization before creating a CD-ROM with MP3 or any other codec format. Due to variations in the different encoders and variations of the MP3 codec and the different bit rates used to record MP3 discs, the DVD 27 may not be able to play all discs with MP3 files. We cannot guarantee complete compatibility with MP3 discs, even though they may play on a computer. This is normal and does not indicate a problem with the DVD 27. Note, also, that when a multisession disc with both standard CD audio and MP3 (or WMA) content is used, the DVD 27 will only play the CD audio sections of the disc.
- **WMA Files:** WMA (Windows Media Audio) is an audio compression format developed by the Microsoft® Corporation for use with its Windows Media Player. WMA files may be created with greater compression than MP3 without sacrificing audio quality so that even more songs may be recorded on a disc. Note that there have been a number of versions of Windows Media, and the DVD 27 is compatible only with files that end in the "wma" extension and that were recorded using the Windows Media Series 8 encoding.
- **JPEG Files:** "JPEG" is the acronym used to identify image files recorded according to specifications established by Joint Photographic Experts Group for compressing still images. Identified by the file extension ".jpg" when they are recorded on most computers, JPEG files may be created by a digital still camera and then edited and "burned" to a disc in your personal computer, recorded on a CD-ROM disc from film images by a photo processor, or scanned from printed photos into your personal computer and then burned onto a CD-ROM.

Discs containing MP3, WMA or JPEG files are navigated and controlled differently from standard DVDs and CDs. When a disc containing one or more of these types of files is loaded in the DVD 27, the Player Information menu screen will appear.



This screen will display a list of the main folders contained on the disc. The elapsed time will appear in the upper right corner of the screen. It isn't possible to change the time display, and the Time Search function is not available.

MP3 or WMA Disc Playback

MP3 and WMA discs may contain 200 tracks or even more. To get the best overview about all tracks on the disc and their names and to select them comfortably, use the on-screen display rather than the front-panel display. The front-panel display will only show the number and the elapsed time of the track being played for WMA files.

The supported bit rate for WMA files is between 64k bits and 320k bits. The supported bit rate for MP3 files is between 32k bits and 320k bits.

- To select a folder (if any), press the **▲▼ Navigation Buttons 10** until the desired folder name is high-lighted, then press the **Enter Button 7**.
- To select a track, press the **▲▼ Navigation Buttons 10** until the desired track name is highlighted. To start play of the track selected on the list, press the **Enter Button 7** or **Play Button 4 17**.

During MP3/WMA playback, some of the standard CD/DVD playback controls operate in their normal fashion:

- You may skip forward to the next track on the disc by pressing the **Skip/Next Button 8 16**.
- You may skip back to the previous track on the disc by pressing the **Skip/Prev Button 7 15**.
- Press the **Pause Button 5 13** to momentarily stop playback. Press the **Play Button 4 17** to resume play. Press the **Stop Button 6 19** to enter stop mode.

- Press the **Search Forward 8 16** or **Search Reverse 7 15** buttons, for fast search of a track. Press the **Play 4 17**, **Pause 5 13** or **Stop Button 6 19** to end fast play.
- Slow-play is not available during MP3/WMA playback.
- You may play an MP3 or WMA disc in random mode like a normal CD. You may also access the Random function while an MP3 or WMA disc is playing by pressing the **Random Button 25**.
- The Repeat function may be accessed during playback of an MP3 or WMA disc by pressing the **Repeat Button 30** on the remote. Repeatedly press the **Repeat Button 30** to scroll through the options of Repeat 1 (repeat one file), Repeat All (repeat all files) or Repeat Folder (repeat all files within the current folder). The next press will turn the repeat function off. Repeat A-B is not available during MP3/WMA playback.

NOTES ON MP3 AND WMA PLAYBACK

- During playback, the front-panel display and the time indicator on the screen above the list will show the elapsed time of the track being played. Other time display options are not available with MP3/WMA playback.
- The DVD 27 is only compatible with standard MP3- and WMA-encoded discs. Other compressed audio formats used for Internet audio downloads will not play on the DVD 27.
- Due to the differences in various versions of the MP3 and WMA formats, and the many differences between the CD-R machines used to record discs on a computer, it is possible that some discs may not play on the DVD 27 even though they will work on a computer. This is normal and does not indicate a fault with the unit.
- When a multisession disc with both standard CD audio and MP3 or WMA content is in use, the DVD 27 will play only the CD audio sections of the disc. Track numbers will be visible in the display, but the files will not be decoded.
- If a disc containing MP3, WMA and/or JPEG files is created in more than one session, the DVD 27 may not recognize files added during the later sessions, especially if the disc was finalized after the first session.

MP3, Windows Media and JPEG Playback

- When a disc with multiple folders is playing, only tracks from one folder can be displayed and played at a time. Select the desired folder and press the **Play Button 4** **17** or **Enter Button 7** to start the first track. To see and play tracks from other folders, you must first select the root folder using the **▲▼ Navigation Buttons 10**, and press the **Enter Button 7** to open or close that folder. You may then navigate an open folder and select the desired folder. Press the **Enter Button 7** to open the folder, and select the desired track. Then press the **Play Button 4** **17**.
- Only stereo audio playback is available for MP3 and WMA discs.
- Programmed playlists are not available for MP3/WMA discs.
- Use the **▲▼◀▶ Navigation Buttons 10** to select the **DISC INF** Submenu icon on the left side of the screen, and press the **Enter Button 7** to view it. If the disc contains ID3 tag information, then the current MP3 track information will appear: song title, artist, album, year, genre, and any comments. For WMA and JPEG files, only the file name will appear.

JPEG Playback

The DVD 27 is capable of recognizing JPEG still-image files and displaying them. When a disc or folder containing JPEG files is loaded, the **JPEG Disc-Type Indicator A** will light in the **Main Information Display 1**. The disc will immediately begin displaying the images on the disc in order.

When viewing JPEG images, the **Angle Button 5** may be used to rotate the image. With the image on-screen, press the **Angle Button 5** once to display the current orientation of the image, usually +0. Press the **Angle Button 5** again within one second to rotate the image clockwise 90 degrees. The new orientation of +90 will be displayed. Each additional press of the **Angle Button 5** will continue to rotate the image clockwise by 90 degrees.

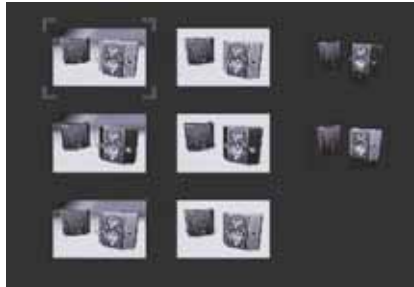

You may use the **Zoom Button 23** to enlarge a JPEG image, and the **▲▼◀▶ Navigation Buttons 10** to explore the enlarged image.

You may view thumbnails of the images in the selected folder by pressing the **Disc Menu Button 12**. When the images appear on screen, you may use the **▲▼◀▶ Navigation Buttons 10** to move the picture frame around until the desired image is selected. Press the **Enter Button 7** to display a full-size view of that image.



Troubleshooting Guide

Troubleshooting Guide

Symptom	Possible Cause	Solution
Unit does not turn on	<ul style="list-style-type: none"> No AC power 	<ul style="list-style-type: none"> Check AC power plug and make certain any switched outlet is turned on.
Disc does not play	<ul style="list-style-type: none"> Disc loaded improperly 	<ul style="list-style-type: none"> Load disc label-side up; align the disc with the guides and place it in its proper position. Incorrect disc type Check to see that disc is CD, CD-R, CD-RW, DivX, VCD, MP3, WMA, JPEG, DVD-R, DVD-RW, DVD+R, DVD+RW (standard conforming) or DVD-Video; other types will not play. Invalid Region Code Use Region 2 or Open Region (0) disc only. Rating is above parental preset Enter password to override or change rating settings.
No picture	<ul style="list-style-type: none"> Intermittent connections Wrong input Progressive Scan output selected Video Off feature active 	<ul style="list-style-type: none"> Check all video connections. Check input selection of TV or receiver. Use Progressive Scan mode only with compatible TV. If needed, press the Progressive Scan/Interlaced Button 22 to toggle to the correct mode. Press Video Off Button 27 to reactivate video circuitry (see page 23)
No sound	<ul style="list-style-type: none"> Intermittent connections Incorrect digital audio selection DVD disc is in fast or slow mode Surround receiver not compatible with 96kHz PCM audio 	<ul style="list-style-type: none"> Check all audio connections. Check digital audio settings. There is no audio playback on DVD discs during fast or slow modes. Use analog audio outputs.
Picture is distorted or jumps during fast forward or reverse play	<ul style="list-style-type: none"> MPEG-2 decoding 	<ul style="list-style-type: none"> It is a normal artifact of DVD playback for pictures to jump or show some distortion during rapid play.
Some remote buttons do not operate during DVD play; prohibited symbol  appears (see below)	<ul style="list-style-type: none"> Function not permitted at this time 	<ul style="list-style-type: none"> With most discs, some functions are not permitted at certain times (e.g., Track Skip) or at all (e.g., direct audio track selection).
The OSD menu is in a foreign language	<ul style="list-style-type: none"> Incorrect OSD language 	<ul style="list-style-type: none"> Change the display language selection.
The  symbol appears	<ul style="list-style-type: none"> Requested function not available at this time 	<ul style="list-style-type: none"> Certain functions may be disabled by the DVD itself during passages of a disc.
Picture is displayed in the wrong aspect ratio	<ul style="list-style-type: none"> Incorrect match of aspect ratio settings to disc 	<ul style="list-style-type: none"> Change aspect ratio settings.
Remote control inoperative	<ul style="list-style-type: none"> Weak batteries Sensor is blocked 	<ul style="list-style-type: none"> Change both batteries. Clear path to sensor or use optional outboard remote sensor.
Disc will not copy to VCR	<ul style="list-style-type: none"> Copy protection 	<ul style="list-style-type: none"> Many DVDs are encoded with copy protection to prevent copying to VCR.
Password not accepted.	<ul style="list-style-type: none"> Incorrect password being used or password has been forgotten. 	<ul style="list-style-type: none"> Stop play of disc. Press and hold the Clear Button 31 until the display blinks. This resets the password and all settings to their defaults.

Technical Specifications

Applicable Disc:	Disc formats: 5 inch (12 cm) or 3 inch (8 cm) DVD Video, Standard conforming DVD+RW, DVD+R, DVD-R, DVD-RW and DVD-ROM, DivX, VCD, CD, CD-R, MP3, WMA, JPEG or CD-RW discs, Regio code: DVD Movie disc with Code 2 or 0 only. DVD-Layers: Single Side/Single Layer, Single Side/Dual Layer, Dual Side/Single Layer, Dual Side/Dual Layer Audio formats: Linear PCM, MPEG, Dolby Digital or DTS
Video Signal System:	PAL/NTSC
Composite Video Output:	1 V _{p-p} /75 Ohms, sync negative polarity
S Video Output:	Y/Luminance: 1 V _{p-p} /75 Ohms, sync negative polarity C/Chrominance: 0.286 V _{p-p}
Component Video Output:	Y: 1 V _{p-p} /75 Ohms, sync negative polarity Cr: 0.7 V _{p-p} /75 Ohms Cb: 0.7 V _{p-p} /75 Ohms
Analog Audio Output:	2 V _{rms} max
Frequency Response:	DVD (Linear PCM): 2 Hz - 22 kHz +0/-0.5 dB (48 kHz sampling) 2 Hz - 44 kHz +0/-0.5 dB (96 kHz sampling) CD: 2 Hz - 20 kHz +0/-0.5 dB
Signal/Noise Ratio (SNR):	105 dB (A-weighted)
Dynamic Range:	DVD: 100 dB (18 Bit) / 105 dB (20 Bit) CD/DVD: 96 dB (16 Bit)
THD/1kHz:	DVD/CD: 0.0025 %
Wow & Flutter:	Below Measurable Limits
AC Power:	100 - 240 V/50 ~ 60 Hz
Power Consumption:	1 Watts (Standby)/11 Watts (Max)
Dimensions (WxHxD):	440 x 50 x 285 mm
Weight:	4.0 kg

Depth measurement includes knobs and connectors.

Height measurement includes feet and chassis.

All specifications subject to change without notice.

Harman Kardon and Power for the digital revolution are trademarks of Harman Kardon, Inc.

Manufactured under license from Dolby Laboratories. Dolby, Dolby Digital, ProLogic and the double-D symbol are trademarks of Dolby Laboratories. Confidential.

Unpublished Work. © 1992-1997 Dolby Laboratories, Inc. All rights reserved.

DTS is a trade mark of Digital Theater Systems, Inc.

Microsoft, Windows and WMA are either registered trademarks or trademarks of Microsoft Corporation in the United States and/or other countries.

DivX, DivX Certified, and associated logos are trademarks of DivX Networks, Inc and are used under license.

This product incorporates copyright protection technology that is protected by method claims of certain U.S. patents and other intellectual property rights owned by Macrovision Corporation and other rights owners. Use of this copyright protection technology must be authorized by Macrovision Corporation and is intended for home and other limited viewing uses only unless otherwise authorized by Macrovision Corporation. Reverse engineering or disassembly is prohibited.

harman/kardon

H A Harman International Company
250 Crossways Park Drive, Woodbury, New York 11797
www.harmankardon.com
Harman Consumer Group International:
2, Route de Tours, 72500 Château-du-Loir, France
© 2006 Harman Kardon, Incorporated
Partnumber: CQX1A1051Z